

Fusion

GHSS 52"H Refrigerated Self-Service Case w/ Curved Profile

Structural Concepts®

DELIVERING FRESH. ALWAYS.™

- **GHSS452RLB** 51"L x 42-3/4"D x 51-1/4"H
- **GHSS552RLB** 62-7/8"L x 42-3/4"D x 51-1/4"H
- **GHSS652RLB** 75-3/8"L x 42-3/4"D x 51-1/4"H
- **GHSS852RLB** 99-3/4"L x 42-3/4"D x 51-1/4"H
- **GHSS1052RLB** 123-3/8"L x 42-3/4"D x 51-1/4"H
- **GHSS1252RLB** 148-1/2"L x 42-3/4"D x 51-1/4"H

Included

- Remote DX refrigeration
- LED top & shelf lights
- One year parts & labor warranty
- Stainless steel rear exterior
- Warmest average product temperature of 40°F or less



GHSS852RLB

Specify	Standard Features	Additional Options
EXTERIOR COLOR	• Laminate (stock colors)	• Laminate (non-stock colors) • Powder coated (stock/non-stock colors) • Powder coated Silversan Black • Stainless steel
INTERIOR COLOR	• Powder coated Silversan Black	• Stainless steel
LOWER FRONT PANEL COLOR	• Powder coated Silversan Black	• Powder coated (stock/non-stock colors) • Stainless steel
BASE SUPPORT	• Rail system for shims	
BUMPER FRONT	• 1" Boston bumper (specify color)	• 1" Stainless steel plate rail bumper
END PANELS	• Full w/stainless steel mirror interior	• Cutaway w/glass • None (specify per line-up)
PRICE TAG MOLDING	• None	• 1" Price tag molding (black or silver) • Universal price tag molding (clear w/ open top)
REAR DOORS	• None (solid back panel)	• Solid rear swinging door(s) w/lock
SHELVING	• 16" & 18" & 22" Solid shelving	• 16" & 18" & 22" Glass shelving
LIGHTS	• LED 3500K w/ frosted lens	• LED 4000K w/ frosted lens
ELECTRICAL CONNECTION	• Electrical leads (remote)	
REFRIGERATION	¹ • Remote DX refrigeration	¹ • Remote w/thermostat, solenoid & TXV
SENSOR	• None	• CPC discharge air sensor (remote)
ACCESSORIES		• Drain strainer • Night curtain, retractable, non-locking • Removable wire security cover, locking

Std Notes: 1 - Read important notes for remote options

Option Notes: 1 - Read important notes for remote options

Intended Environment: Type I - Designed to operate in ambient conditions of 75°F with 55% relative humidity unless noted otherwise in system information below.

Zone	Intended Product To Be Displayed	Warmest Avg Prod Temp ° F
1	Packaged refrigerated products-Prechilled to Warmest Avg Prod Temp.	40



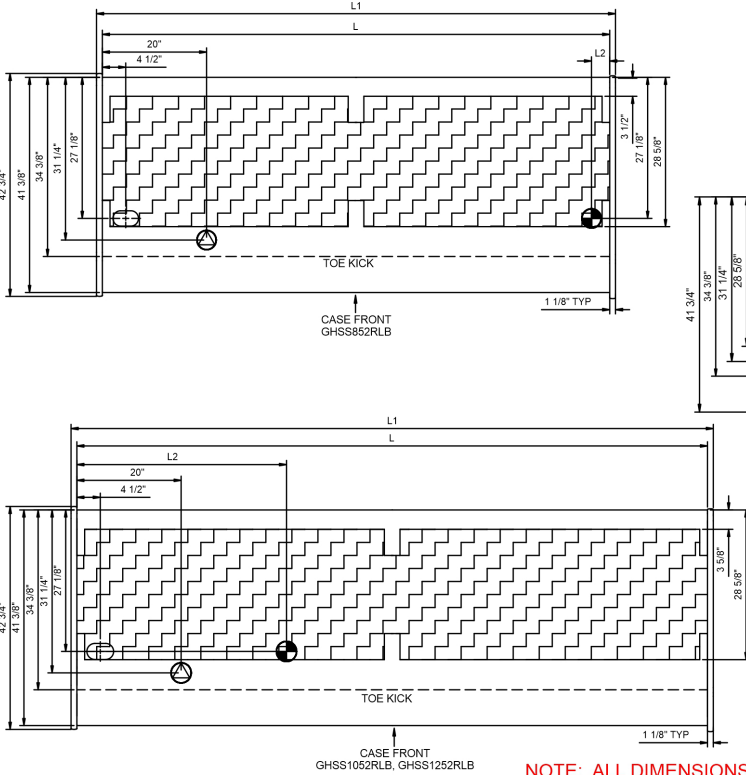

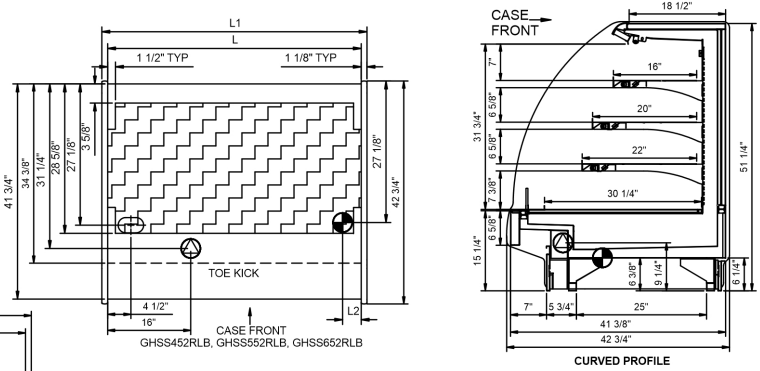

PLAN VIEW



SIDE VIEW



NOTE: ALL DIMENSIONS APPROXIMATE

-  **ELECTRICAL JUNCTION BOX**
(SUPPLIED WITH 6" LEADS OR POWER CORD).
-  **REFRIGERATION LINE CONNECTION.**
-  **SELF-CONTAINED CASE SERVICE ACCESS AREA.**
-  **LOCATION OF DRAIN TUBE FOR REMOTE REF. ONLY**
(SUPPLIED WITH 3/4" OR 1 1/2" PVC TUBE).
-  **REMOTE FLOOR SINK & UTILITIES ACCESS AREA.**
-  **DRY CASE SERVICE ACCESS AREA.**

Model Technical Specifications

Model	L"	L1"	L2"	System Circuit Volts		Phs	Freq	Amps ***	Watts	Wires	NEMA Plug	SST	Conv. Rack RTUH	Para. Rack RTUH	Est Wt	
				Remote (DX)	Circuit #1											
GHSS452RLB	48.75	51.00	4	Remote (DX)	Circuit #1	110-120	1	60	1.50	99	2+G	Leads Multiple	20.00	4510	4176	550
				Remote (GLYCOL 35%)	Circuit #1	110-120	1	60	1.78	82	2+G	Leads Multiple	20.00	4510	4176	
GHSS552RLB	60.63	62.88	4	Remote (DX)	Circuit #1	110-120	1	60	2.88	158	2+G	Leads Multiple	20.00	5495	5088	800
				Remote (GLYCOL 35%)	Circuit #1	110-120	1	60	2.62	154	2+G	Leads Multiple	20.00	6480	6000	
GHSS652RLB	73.13	75.38	4	Remote (DX)	Circuit #1	110-120	1	60	2.62	154	2+G	Leads Multiple	20.00	6480	6000	925
				Remote (GLYCOL 35%)	Circuit #1	110-120	1	60	3.04	218	2+G	Leads Multiple	20.00	6480	6000	
GHSS852RLB	97.50	99.75	4	Remote (DX)	Circuit #1	110-120	1	60	2.07	136	2+G	Leads Multiple	24.00	8450	7824	1,120
				Remote (GLYCOL 35%)	Circuit #1	110-120	1	60	3.56	199	2+G	Leads Multiple	20.00	8450	7824	
GHSS1052RLB	121.13	123.38	40	Remote (DX)	Circuit #1	110-120	1	60	3.81	231	2+G	Leads Multiple	20.00	10757	9960	1,300
GHSS1252RLB	146.25	148.50	45	Remote (DX)	Circuit #1	110-120	1	60	4.51	354	2+G	Leads Multiple	20.00	12960	12000	1,500
				Remote (GLYCOL 35%)	Circuit #1	110-120	1	60	5.35	299	2+G	Leads Multiple	20.00	12960	12000	

*** Does not include electric defrost on freezer models.

Regulatory Approvals:

All Models
 Accordance with AHRI Std 1200
 ETL Listed to UL 471
 ETL Listed to CAN/CSA 22.2 No. 120
 ETL Sanitation to NSF/ANSI 7



In Accordance with
AHRI Std 1200

DOE 2017
 Energy Efficiency
 Compliant

Important Notes:

- 1) REMOTE REFRIGERATION NOTE: Condensing unit not included, floor drain required.
- 2) ELECTRICAL NOTE: If GFCI is required, a GFCI breaker MUST be used in lieu of a GFCI receptacle.
- 3) 45" minimum door entry clearance required (without shipping skid).
- 4) Units must be shimmed during installation to ensure the unit is level and plumb.

⚠ WARNING: This product can expose you to chemicals, including Urethane (Ethyl Carbamate), which are known to the State of California to cause cancer and birth defects or other reproductive harm. For more information go to www.P65Warnings.ca.gov.